

**NEW**

Small Precise X-Ray Inspection  
Equipment X5600

**SEAMARK**  
Ray solution

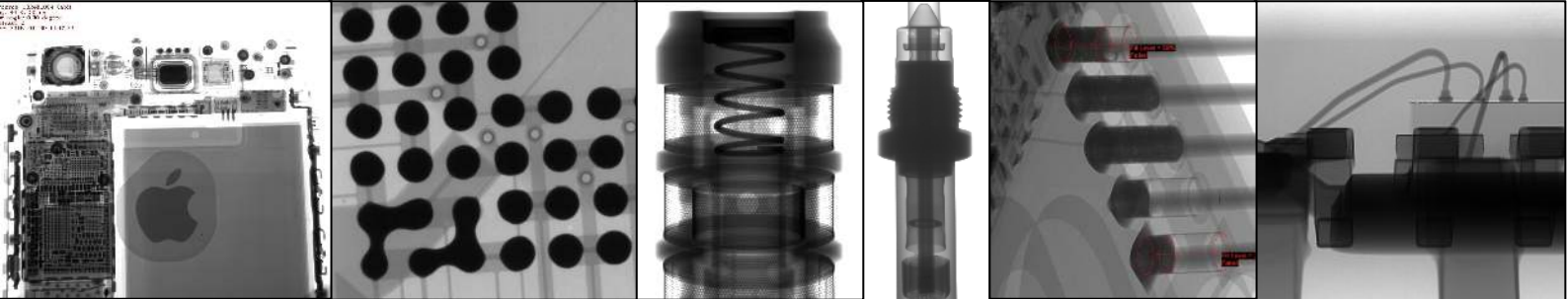

X-Ray Inspection Equipment

# X5600

Shenzhen Zhuomao Technology Co.,Ltd  
Seamark ZM Technology Group ( H.K. ) Company Ltd



## X5600

X5600 is a small precise microfocus X-ray inspection equipment, suitable for R&D enterprise, laboratories, quality inspection rooms etc., It is the first choice for X-ray inspection of small parts.

### Application Advantage

- ◆ Miniaturized equipment, easy to install and operate
- ◆ Applicable to Chip, BGA/CSP, Wafer, SOP/QFN, SMT and PTU packaging, Sensors and other fields products inspection.
- ◆ High resolution design to get the best image in a very short time.
- ◆ Infrared automatic navigation and positioning function can select the shooting location quickly.
- ◆ CNC inspection mode which can quickly and automatically inspect multi-point array.
- ◆ Inclined multi-angle inspection makes it easier to inspect sample defects.
- ◆ Simple software operation, low operating costs
- ◆ Long lifespan

### X-Ray Tube Source Specification

Type	Sealed Micro-Focus X-Ray Tube
Voltage Range	40-90KV
Current Range	10-200 $\mu$ A
Max Output Power	8 W
Micro Focus Spot Size	15 $\mu$ m

### Flat Panel Detector Specification

Type	TFT Industrial Dynamic FPD
Pixel Matrix	768 $\times$ 768
Field of View	65mm $\times$ 65mm
Resolution	5.8Lp/mm
Frame ( 1 $\times$ 1)	40fps
A/D Conversion Bit	16bits

### Automatic Void Ratio Calculation

- Enhanced BGA inspection function  
X5600 can quickly select and mark a single solder ball, or select the solder balls to be inspected by matrix box ; it can manually or automatically identify BGA solder balls and complete the inspection. Follow the system guidelines to easily complete the inspection process and ensure accurate and reliable inspection results.

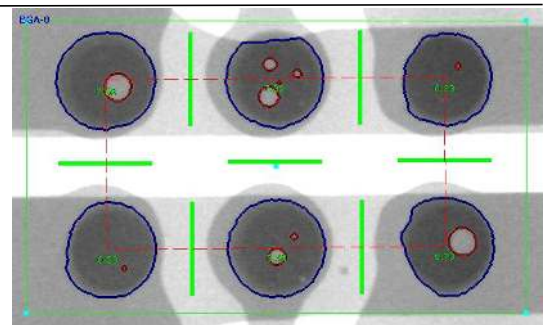

### Size Measurement

- Measuring tools  
Distance, distance ratio, lines distance, angle, arrow mark, circle radius, points distance, circle centers distance, circumference, hand-drawn polygon, hand-drawn freeform etc., can add text description.

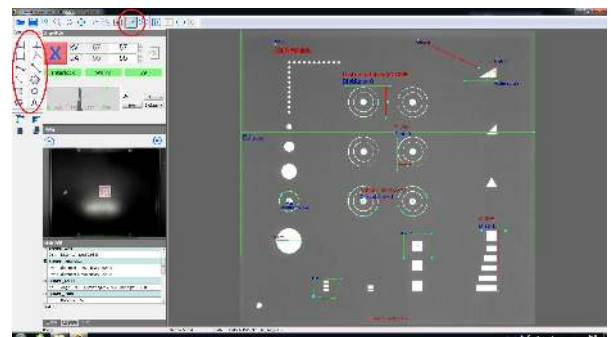

## Defect Inspection

- Automatically detect defects  
X5600 can automatically detect size, area, broken wire, bridging etc
- Customizable image algorithm  
Customerized software algorithms based on product features and request to achieve fully automatic defect inspection algorithms, including Y/N, crack, broken wire, offset, size, and quantity etc.

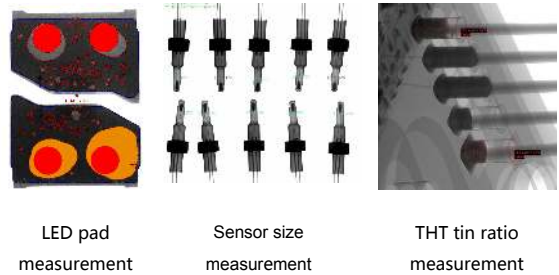

## CNC Inspection

- CNC automatic operation inspection  
X5600 support CNC multi-point automatic inspection, based on product feature set multi-point coordinates for automatic inspection.
- Automatic CNC operation detection  
Automatically save images, generate reports, also support batch inspection.

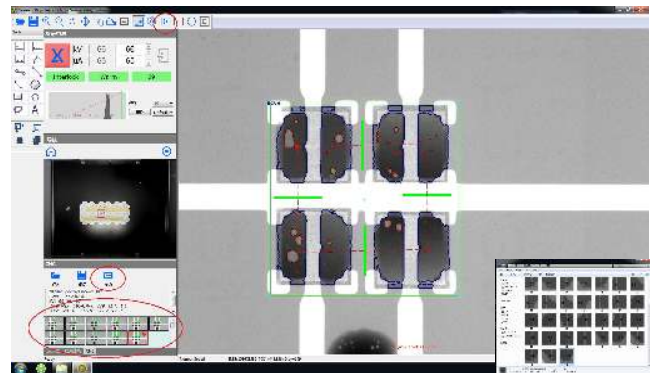

## Tilt / Rotate Function

- Tilt angle inspection function  
The X5600 detector support a tilt angle of  $\pm 30^\circ$ . For cases where the photo taken on the front of a special device cannot identify the defect feature, the tilt function can be used to observe the device features at multiple angles, making it easier to analyze and identify the defect.
- 360°Rotating photo inspection function  
Equipped with a rotating manipulator that can rotate 360 degrees to take images, no dead angle. defects.

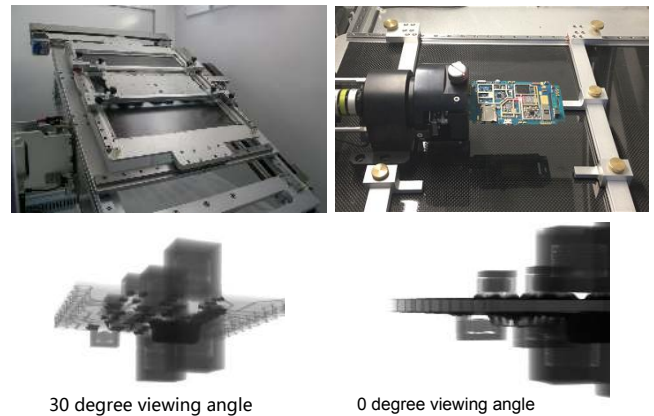

## Radiation Safety



### Safety Considerations

- Obtained an exemption record from the Ministry of Ecology and Environment of the People's Republic of China

The X5600 obtained the certification document (sixth batch) for the exemption record of radioisotope and ray device of the Ministry of Ecology and Environment, with the record number [Yuehuan [2018] No. 1688]. The radiation device using this product model of our company can be exempted from the radiation safety license.

- Design for ultra-small leakage

According to the "Ionizing Radiation Protection and Radiation Source Safety Basic Standards" (GB18871-2002), the radiation protection exemption standard is  $\leq 1\mu\text{Sv/h}$ , the design standard of this product is  $\leq 0.5\mu\text{Sv/h}$ , and the operator is controlled by the amount of radiation received within one year Within 0.18mSv, it is equivalent to 1/10 of the amount of radiation in the natural environment.

- Multi-protection safety element

Equipped with OMRON's safety control element, triple safety protection sensor, and direct connection control method with ray source, it fully complies with CE specifications and SEMI S2/S8 specifications of the semiconductor industry.

### Radiation test site



## Dimensions

Model X5600

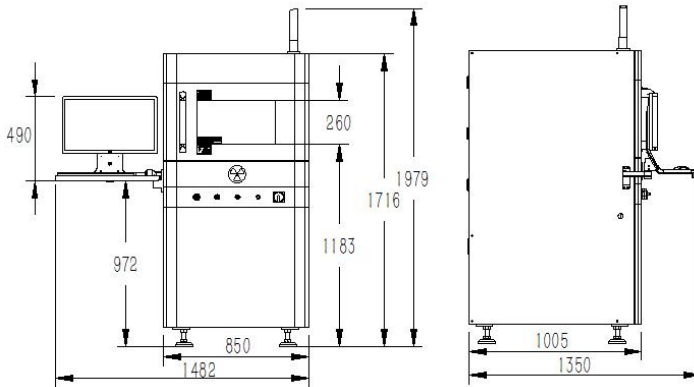

### Parameters

Dimensions	L850mm×W1000mm×H1700mm
Input Power	220V 10A/110V 15A 50-60HZ
Max Sample Size	280mm×320mm
Control System	Industrial PC WIN7/ WIN10 64bits
Net Weight	About 750KG



Shenzhen Zhuomao Technology Co., Ltd.  
Seamark ZM Technology Group ( H.K. ) Company Ltd

Shenzhen Zhuomao Technology Co., Ltd  
**Email:** [anne@zhuomao.com.cn](mailto:anne@zhuomao.com.cn)    [wfm75@163.com](mailto:wfm75@163.com)  
**Tel/Skype/Whatsapp/wechat:** +86-156-0298-9546  
**Web:** [www.seamarkzm.com](http://www.seamarkzm.com)  
**Address:** Building 10, Huaide Cuihai Industrial Park, Fuyong, Bao'an district, Shenzhen, China.